

**Philips  
Business  
Solutions**



**EN User Manual**



**TYPE Nr.      BDS4222B  
                      BDS4222V  
                      BDS4222R**

**PHILIPS**



**TABLE OF CONTENTS**

**1 IMPORTANT NOTES AND SAFETY INSTRUCTIONS . . . . . 3**

1.1 Safety Instructions . . . . . 3

1.2 Warnings and Precautions . . . . . 5

1.2.1 Note to the CATV System Installer. . . . . 5

1.3 Cleaning & Care . . . . . 6

1.4 End-Of-Life Disposal. . . . . 6

**2 REGULAROTY NOTICE . . . . . 7**

**3 UNPACKING AND INSTALLATION . . . . . 9**

3.1 Unpacking . . . . . 9

3.2 Package Contents . . . . . 9

3.3 Installation Notes . . . . . 10

**4 PARTS AND FUNCTIONS . . . . . 11**

4.1 Available Functionality by Monitor Type . . . . . 11

4.2 Front View . . . . . 12

4.3 Rear View . . . . . 13

4.4 Remote Control . . . . . 14

**5 CONNECTIONS TO EXTERNAL EQUIPMENT . . . . . 15**

5.1 Connecting TV or CATV . . . . . 15

5.2 Connecting a VCR . . . . . 16

5.3 Connecting a DVD Player . . . . . 17

5.4 External Audio Connection . . . . . 18

5.5 Connecting a PC. . . . . 19

**6 BASIC FUNCTIONS . . . . . 21**

6.1 Powering ON / OFF . . . . . 21

6.2 Selecting Signal Source . . . . . 21

6.3 Volume Adjustment . . . . . 22

6.4 On-screen Display menu . . . . . 23

6.5 On-Screen Display Status. . . . . 23

6.6 Understanding Widescreen Modes . . . . . 24

6.6.1 4:3 (Square) Content . . . . . 24

6.6.2 Widescreen Content . . . . . 24

6.7 Changing Aspect Ratios . . . . . 25

**7 ADVANCED FUNCTIONS . . . . . 27**

7.1 Picture Controls . . . . . 27

7.1.1 Adjusting Picture Settings. . . . . 27

7.1.2 Picture-In-Picture (PIP) / Side-by-Side Picture (POP) . . . . . 29

7.1.3 Selecting Color Temperature. . . . . 32

7.1.4 Fine Tuning RGB(VGA) Mode . . . . . 32

7.1.5 Fit Picture To Size Of Monitor . . . . . 33

7.2 Sound Controls . . . . . 34

7.2.1 Adjusting Sound Settings . . . . . 34

7.2.2 Built-in Amplification (Speaker) . . . . . 35

7.2.3 Fixed / Variable Audio Output . . . . . 35

7.3 OSD Menu Language . . . . . 36

7.4 Power Save Mode. . . . . 36

7.5 Information Display . . . . . 37

7.6 Pixel Shift Function . . . . . 37

7.7 Burn-in Recovery . . . . . 38

- 7.8 Teletext ..... 39
- 7.9 TV Functions (BDS4222R only) ..... 41
  - 7.9.1 Initial Set Up ..... 41
  - 7.9.2 Manual Channel Search ..... 42
  - 7.9.3 Channel Edit ..... 43
- 7.10 On-Screen Status Display (TV Mode) (BDS4222R only) ..... 43
  - 7.10.1 Changing Channels ..... 43
  - 7.10.2 Sound Type ..... 44
- 8 TECHNICAL SPECIFICATIONS .....45**
  - 8.1 Specifications ..... 45
- 9 CLEANING AND TROUBLESHOOTING .....49**
  - 9.1 Cleaning ..... 49
  - 9.2 Troubleshooting ..... 50
- 10 LIMITED WARRANTY (EUR).....51**
- 11 LIMITED WARRANTY (USA).....55**

## 1. IMPORTANT NOTES AND SAFETY INSTRUCTIONS

### 1.1 SAFETY INSTRUCTIONS

- Read and keep these instructions.
- Heed all warnings.
- Follow all instructions.
- Do not use this apparatus near water.
- Disconnect from the electric outlet before cleaning. Do not use liquid or aerosol cleaners. Clean only with a slightly damp cloth.
- Do not block any of the ventilation openings. Install in accordance with the manufacturers instructions.
- Do not install in direct sunlight, near any heat sources such as radiators, heat registers, stoves, or other apparatus (including amplifiers) that produce heat.
- Do not defeat the safety purpose of the polarized or grounding type plug. A polarized plug has two blades with one wider than the other. A grounding type plug has two blades and a third grounding prong. The wide blade or third prong are provided for your safety. When the provided plug does not fit into your outlet, consult an electrician for replacement of the obsolete outlet.
- Do not remove cover, to prevent electric shock. Refer servicing to qualified service personel only.
- Unauthorized modification of this equipment or usage of an unshielded connecting cable may cause excessive interference.
- Adjust only those controls that are covered by the operating instructions. Improper adjustment of other controls can result in damage which often requires extensive work by a qualified technician to restore the unit to normal operation.
- Use in well-ventilated area and do not block any of the ventilation openings. Install in accordance with the manufacturer's instructions.
- The unit must be operated from the type of power source indicated on the label. If the type of available power is unknown, consult your dealer or local power company.
- Protect the power cord from being walked on or pinched particularly at plugs, convenience receptacles, and the point where they exit from the apparatus power outlet. This is a safety feature. If you are unable to insert the plug into the outlet, contact your electrician. Do not alter the plug; this will defeat the safety feature.
- Do not overload wall outlets and extension cords as this can result in a risk of fire or electric shock.
- If the picture displayed looks abnormal, turn off the unit and disconnect it from the electric outlet. Verify your signal wire connections and reconnect the display to the electric outlet.
- Only use attachments/accessories specified by the manufacturer.



- Use only with a cart, stand, tripod, bracket, or table specified by the manufacturer, or sold with apparatus. When a cart is used, use caution when moving the cart/apparatus combination to avoid injury from tip-over.
- Unplug this apparatus during lightning storms or when unused for long periods of time.
- Refer all servicing to qualified service personnel. Servicing is required when the apparatus has been damaged in any way, such as power-supply cord or plug is damaged, liquid has been spilled or objects have fallen into apparatus, the apparatus has been exposed to rain or moisture, does not operate normally, or has been dropped.
- This product may contain lead and mercury. Disposal of these materials may be regulated due to environmental considerations. For disposal or recycling information, please contact your local authorities or the Electronic Industries Alliance: [www.eiae.org](http://www.eiae.org)
- **Damage Requiring Service:**  
The appliance should be serviced by qualified service personnel when:
  - The power supply cord or the plug has been damaged or frayed.
  - Objects have fallen, or liquid has been spilled into the appliance.
  - The appliance has been exposed to rain.
  - The appliance does not appear to operate normally or exhibits a marked change in performance.
  - The appliance has been dropped, or the enclosure damaged.
  - Unit does not operate normally when the operating instructions are followed.
- **Tilt/Stability:**
  - All displays must comply with recommended international global safety standards for tilt and stability properties of its cabinet design.
  - Do not compromise these design standards by applying excessive pull force to the front, or top, of the cabinet which could ultimately overturn the product.
  - Do not endanger yourself, or children, by placing electronic equipment/toys on the top of the set and cause product damage and/or personal injury.
  - Do not place the unit on an unstable cart, stand or table. Or the product may fall, causing serious damage.
- Do not place the unit on a bed, sofa, rug, or similar surfaces.
- **Wall or Ceiling Mounting:**  
The appliance should be mounted to a wall or ceiling only as recommended by the manufacturer.
- **Power Lines:**  
An outdoor antenna should be located away from power lines.

- Outdoor Antenna Grounding:
  - If an outside antenna is connected to the receiver, be sure the antenna system is grounded so as to provide some protection against voltage surges and built up static charges.
  - Section 810 of the National Electric Code, ANSI/NFPA No. 70-1984, provides information with respect to proper grounding of the mast and supporting structure, grounding of the lead-in wire to an antenna discharge unit, size of grounding connectors, location of antenna-discharge unit, connection grounding electrodes, and requirements for the grounding electrode.
- Object and Liquid Entry:

Care should be taken so that objects do not fall and liquids are not spilled into the enclosure through openings.
- Battery Usage:

CAUTION: To prevent battery leakage that may result in bodily injury, property damage, or damage to the unit.

  - Install all batteries correctly, with + and - aligned as marked on the unit.
  - Do not mix batteries (old and new or carbon and alkaline, etc.).
  - Remove batteries when the unit is not used for a long time.

## 1.2 WARNINGS AND PRECAUTIONS

### 1.2.1 NOTE TO THE CATV SYSTEM INSTALLER

This reminder is provided to call the CATV system installer’s attention to Article 820-40 of the NEC that provides guidelines for proper grounding and, in particular, specifies that the cable ground must be connected to the grounding system of the building, as close to the point of cable entry as practical.

#### KNOW THESE SAFETY SYMBOLS



- This lightning flash with arrow-head within a triangle indicates uninsulated material within your unit, which can cause an electric shock. For the safety of everyone in your household, do not remove product cover.
- For the safety of everyone in your household, do not remove product cover. The exclamation point within a triangle calls attention to features for which you must read the enclosed literature closely to prevent operating and maintenance problems.

### **WARNING**

To reduce the risk of fire or electric shock, this appliance must not be exposed to rain or moisture, and objects filled with liquids, such as vases, must not be placed upon this apparatus.

### **CAUTION**

To prevent electric shock, match wide plug blade to wide slot, and fully insert.

### **ATTENTION**

Pour éviter les chocs électriques, introduire la lame la plus large de la fiche dans la bome correspondante de la prise et pousser jusqu'au fond.

## **1.3 CLEANING & CARE**

- To avoid possible shock hazard, please be sure that the television is unplugged from the electrical outlet before cleaning.
- When cleaning the television screen, take care not to scratch or damage the screen surface (avoid wearing jewelry or using anything abrasive).
- Wipe the front of the screen with a clean cloth dampened with water. Use even, easy, vertical strokes when cleaning.
- Gently wipe the cabinet surfaces with a clean cloth or sponge dampened in a solution of cool clear water. Use a clean dry cloth to dry the wiped surfaces.
- Occasionally vacuum the ventilation holes or slots in the cabinet back.
- Never use thinners, insecticide sprays, or other chemicals on or near the cabinet, as they might cause permanent marring of the cabinet finish.
- Do not allow a still image to be displayed for an extended period of time as this can cause a permanent after-image to remain.

## **1.4 END-OF-LIFE DISPOSAL**

- This Philips product and its packaging contain materials that can be recycled and re-used. Specialized companies can recycle your product to increase the amount of reusable materials and minimize the amounts which need to be properly disposed.
- This product might also use batteries, which should not be thrown away when depleted, but should be handed in and disposed of as small chemical waste.
- Please find out about the local regulations regarding the disposal of the television, batteries, and packaging materials whenever you replace existing equipment.



## 2. REGULAROTY NOTICE

### **FCC Compliance Statement**

The equipment has been tested and found to comply with the limits for a Class B digital device, pursuant to part 15 of FCC rules. These limits are designed to provide reasonable protection against harmful interference when the equipment is operated in a commercial environment.

This equipment generates, uses, and can radiate radio frequency energy and, if not installed and used in strict accordance with the instruction manual, may cause harmful interference to radio communications.

There is no guarantee that interference will not occur in a particular installation. If this equipment does cause harmful interference to radio or television reception, which can be determined by turning the equipment off and on, the user is encouraged to try to correct the interference by one or more of the following measures:

- Reorient or relocate the receiving antenna.
- Increase the separation between the equipment and the receiver.
- Connect the equipment into an outlet on a circuit different from that to which the receiver is connected.
- Consult the dealer or an experienced radio/TV technician for help.

Operation of this equipment in a residential area is likely to cause harmful interference in which case the user will be required to correct the interference at the user's own expense.

Shielded interconnected cables and shield power cords must be employed with this equipment to insure compliance with the pertinent RF emission limits governing this device.

Changes or modifications not expressly approved by the manufacturer could void the user's authority to operate the equipment and invalidate the warranty.

### **Canadian Compliance Statement**

This Class B digital apparatus meets all requirements of the Canadian Interference Causing Equipment Regulations.

Cet appareil numérique de la Classe B respecte toutes les exigences du Règlement sur le matériel brouilleur du Canada.



### 3. UNPACKING AND INSTALLATION

#### 3.1 UNPACKING

- The monitor is packed in a carton, together with the standard accessories. Any other optional accessories will be packed separately.
- The weight of the monitor is approx 36kg. Due to the size and weight it is recommended to move it by 2 people.
- The protective glass and the glass substrate are installed on the front of the product. Since both glass can be broken and scraped easily the product has to be handled with care. Never place the monitor with the glass faced down unless it is protected with pads.
- After opening the carton ensure that the content is in good condition and complete.
- When possible use the handles on the back of the monitor for transport.

#### 3.2 PACKAGE CONTENTS

Please verify that you received the following items with your package content:

- 1 Monitor
- 2 Remote Control
- 3 CD-ROM with User Manual
- 4 Power Cable
- 5 Batteries

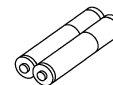
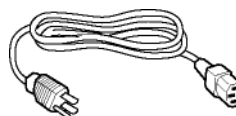
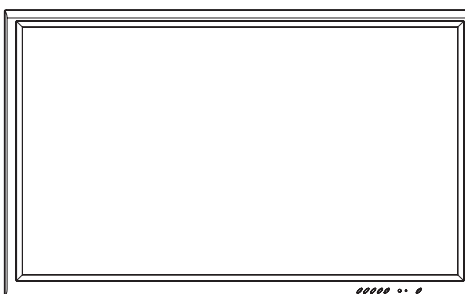

### **3.3 INSTALLATION NOTES**

- Due to the high power consumption, always use the plug exclusively designed for this product. If an extended line is required, please consult your service agent.
- The product should be installed on a flat surface to avoid tipping. The distance between the back of the product and the wall should be maintained for proper ventilation. Avoid installing the product in the kitchen, bathroom or any other places with high humidity so as not to shorten the service life of the electronic components.
- Please ensure the product is installed horizontally. Any 90 degrees clockwise or counter-clockwise installation may induce poor ventilation and subsequent component damage.
- To protect the screen and avoid screen damage, do not display a still picture for a long time.

## 4. PARTS AND FUNCTIONS

### 4.1 AVAILABLE FUNCTIONALITY BY MONITOR TYPE

Connection options vary according to monitor type. The functionality of each monitor type is shown in the table below.

MONITOR TYPE Nr.	BASIC FUNCTIONALITY			VIDEO FUNCTIONALITY			TV
	VGA	DVI	VGA/DVI Audio In	SCART (AV)	Component Video-Audio In	S-Video	Antenna Jack + TV Tuner
<b>BDS4222B</b>	✓	✓	✓	-	-	-	-
<b>BDS4222V</b>	✓	✓	✓	✓	✓	✓	-
<b>BDS4222R</b>	✓	✓	✓	✓	✓	✓	✓

## 4.2 FRONT VIEW

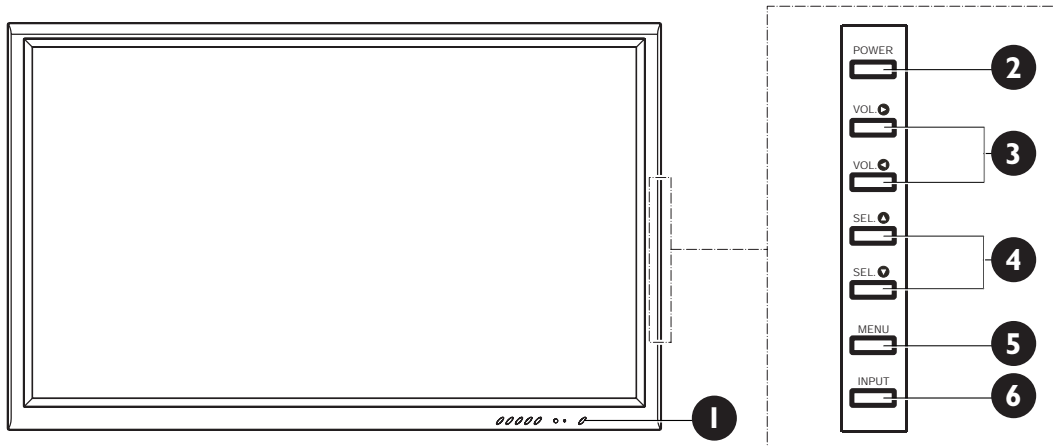

### 1. Status LED

- **Not Illumated = No AC Power detected**

If the main power switch (rear of panel) is turned off, this LED will not illuminate.

- **Orange = Standby (Power OFF) with AC power detected**

The LED will illuminate in orange color if the monitor is shut off but the main power cord is plugged into the back of the unit.

- **Solid Green = Power ON**

### 2. Power (Standby) Button

Turns power on/off from standby mode. There is a wait period between on/off cycles.

### 3. Volume Adjustment Buttons

Use these buttons to adjust volume up and down. These keys also serve as navigation and adjustment keys when On Screen Display menu is engaged.

### 4. Select Buttons

Use these buttons to navigate through the the On Screen Display menu. If an optional TV tuner is installed, these buttons also function as Channel Up/Down.

### 5. Menu Button

Use this button to engage the On Screen Display menu.

### 6. Input Button

Use this button to switch between available inputs.

### 4.3 REAR VIEW

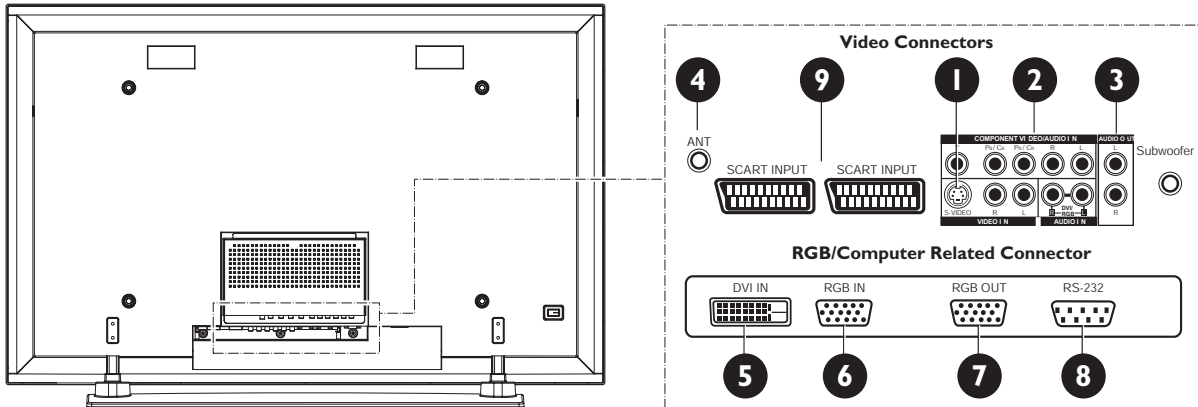

- 1. S-Video Inputs (BDS4222V & BDS4222R only)**  
 Connect S-Video signals from external sources such as VCRs or DVD players.
- 2. Component Video Inputs (BDS4222V & BDS4222R only)**  
 Auto-detecting component video inputs (Y/Pb/Pr or Y/Cb/Cr) for connecting to the component output jacks of a DVD player or Set-Top Box.
- 3. Audio Output**  
 Variable or fixed audio output jacks for connecting to an external audio amplifier.
- 4. Antenna Jack (BDS4222R only)**  
 Connect to TV or CATV antenna.
- 5. Digital DVI Input**  
 Connect to digital video signals from a Set-Top box or Computer.
- 6. RGB(VGA) Input**  
 Connect to RGB(VGA) output of Computer or Set-Top box.
- 7. RGB(VGA) Output**  
 Connect to another computer monitor for daisy chaining applications.
- 8. RS-232 Connector**  
 For factory use only.
- 9. SCART (AV) Connector (BDS4222V & BDS4222R only)**  
 Connect to external sources such as VCRs or DVD players.

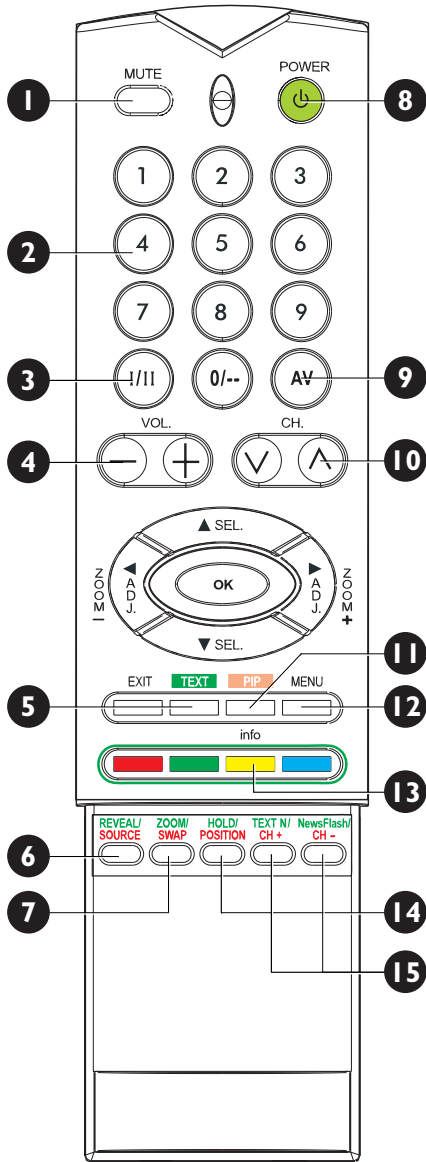

#### 4.4 REMOTE CONTROL

##### 1. Sound Mute On/Off

##### 2. Number Keypad

Use number keypad to select the TV channel you want to watch. (BDS4222R only).

##### 3. Stereo and Dual

Activates Stereo reception for TV or Dual for second language. (BDS4222R only).

##### 4. Volume +/-

Turns volume up or down.

##### 5. Teletext

Activates the TELETEXT mode. (BDS4222R only; see page 39)

##### 6. PIP Source

Changes the input source of the PIP among TV/AV Component input sources. (See page 29)

##### 7. Swap

Swaps the main and sub picture windows under PIP or POP modes. (See page 30)

##### 8. Standby Power On/Off

Push this button to switch on the monitor from Standby mode. Push it again to turn it off to Standby mode.

##### 9. Input Select

Selects the input signal modes sequentially. (See page 21)

##### 10. Channel Up/Down

Changes the TV channels sequentially. (BDS4222R only)

##### 11. PIP (Picture-in-Picture Button)

Activates the PIP (Picture-in-Picture) mode and POP (Side-by-Side) picture mode.

##### 12. Menu

Activates the OSD menu.

##### 13. Info

Shows the status of the monitor.

##### 14. PIP Position

Changes the PIP sub-window to 4 different corner locations. (See page 31)

##### 15. Sub-Picture Channel Up/Down



## 5. CONNECTIONS TO EXTERNAL EQUIPMENT

### 5.1 CONNECTING TV OR CATV

#### Using ANT input (BDS4222R only)

- 1 Connect the RF cable from the antenna or cable socket to the antenna input (ANT) of the monitor.

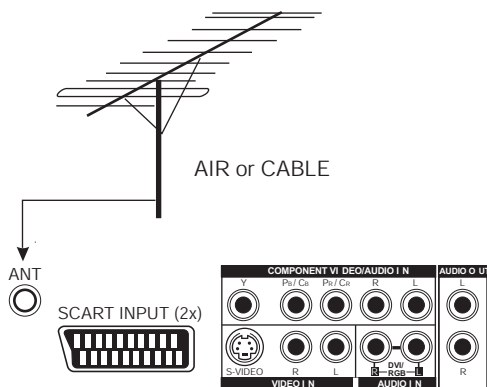

5.2 CONNECTING A VCR

Using SCART (AV) socket input (BDS4222V & BDS4222R only)

- 1 Connect the SCART socket of the videorecorder to the SCART socket of the monitor.
- 2 Connect the videorecorder to the antenna wall socket or cable box.

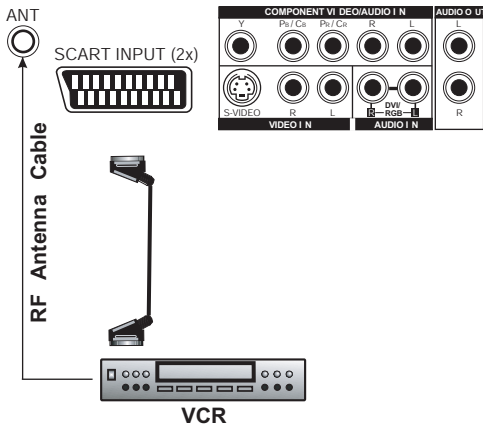

Using S-Video Input (BDS4222V & BDS4222R only)

- 1 Connect the S-Video (4-pin DIN) connector of the VCR to the "S-VIDEO" input of the monitor.
- 2 Connect the red (R) and white (L) audio jacks of the VCR to the R and L audio-in jacks located next to the S-VIDEO connector.

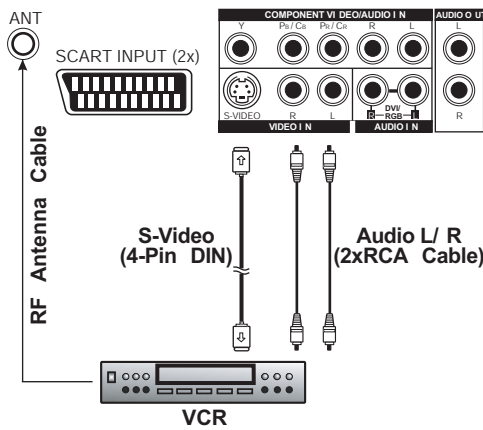

Using TV Input (BDS4222R only)

- 1 Connect the antenna out socket of the videorecorder to the antenna input (ANT) of the monitor.
- 2 Connect the videorecorder to the antenna wall socket or cable box.

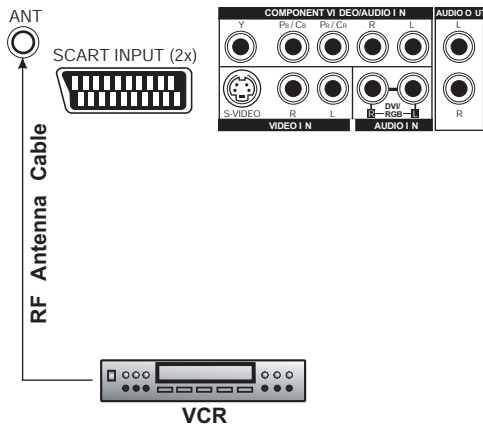

### 5.3 CONNECTING A DVD PLAYER

#### Using SCART (AV) socket input (BDS4222V & BDS4222R only)

- 1 Connect the SCART socket of the DVD player to the SCART socket of the monitor.

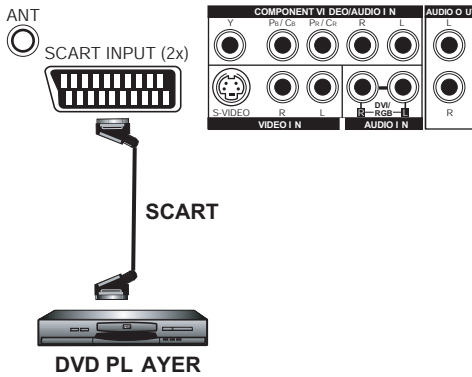

#### Using Component Video Input (BDS4222V & BDS4222R only)

- 1 Connect the green-colored (labeled as "Y") jack of the DVD to the green-colored "Y1" jack of the monitor.
- 2 Connect the red-colored (labeled as "PR/CR") jack of the DVD to the red-colored "PR/CR" jack of the monitor.
- 3 Connect the blue-colored (labeled as "PB/ CB") jack of the DVD to the blue-colored "PB/CB" jack of the monitor.
- 4 Connect the red (R) and white (L) audio jacks of the DVD to the R and L audio-in jacks of the monitor.

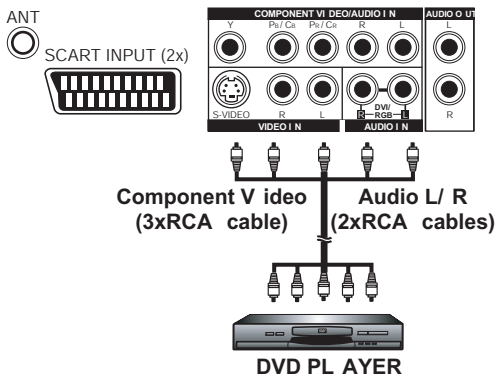

#### Using S-Video Input (BDS4222V & BDS4222R only)

- 1 Connect the S-Video (4-pin DIN) connector of the DVD to the "S-VIDEO" input of the monitor.
- 2 Connect the red (R) and white (L) audio jacks of the DVD to the R and L audio-in jacks located next to the S-VIDEO connector.

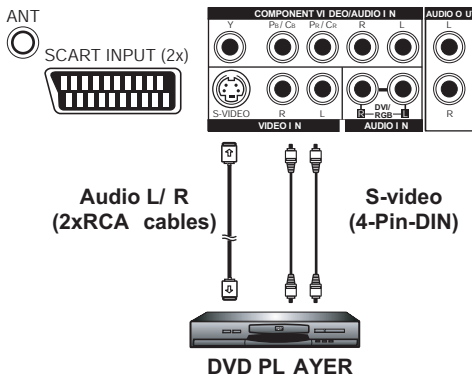

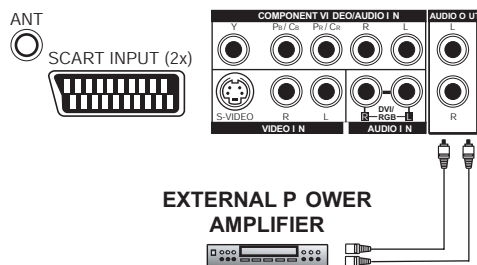

## 5.4 EXTERNAL AUDIO CONNECTION

### Connecting to an External Amplifier

This monitor can be connected to an external amplifier using the AUDIO OUT jacks located on the back of the monitor.

- 1 Connect the red (R) and white (L) AUDIO OUT jacks to the external amplifier or receiver.

**Note:**

The AUDIO OUT RCA jacks can be set to either Fixed or Variable audio output levels. (See page 35 for more information)

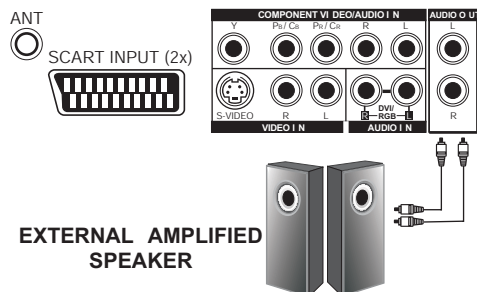

### Connecting External Amplified Speakers

This monitor can be connected to an external set of amplified speakers using the AUDIO OUT jacks located on the back of the monitor.

- 1 Connect the red (R) and white (L) AUDIO OUT jacks to the external amplified speakers.

## 5.5 CONNECTING A PC

### Using RGB(VGA) or DVI Video Input

- 1 Connect the 15-pin D-Sub RGB(VGA) connector of the PC to the RGB-IN connector of the monitor.  
If you have a PC that is equipped with a DVI (Digital Visual Interface), you may connect the PC DVI connector from the PC to the DVI-IN connector of the monitor.
- 2 For both RGB(VGA) and DVI, connect the red (R) and white (L) audio jacks of the PC to the R and L (DVI/RGB) AUDIO IN jacks of the monitor.

#### Note:

A RGB(VGA) loop-out labeled "RGB Out" will allow another RGB(VGA) monitor to be connected. The RGB(VGA) loop-out will display the same signal as the RGB In signal source.

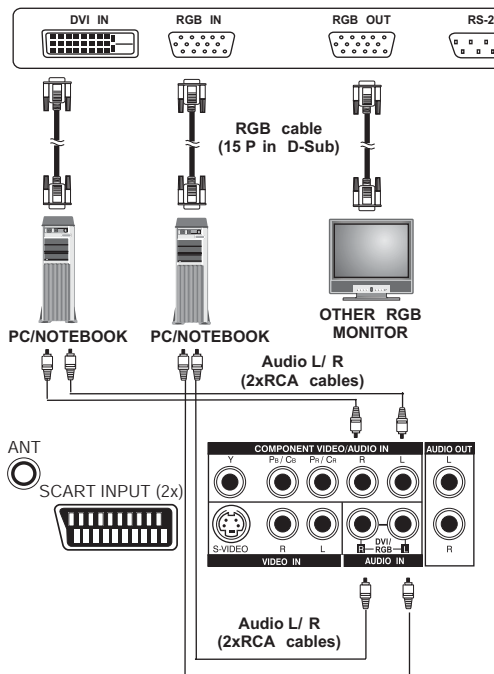

### Setting Up Your Display Using Plug and Play

This display adheres to VESA Plug and Play standard to eliminate complicated and time consuming setup of monitors. This monitor identifies itself to the computer and automatically sends the PC its Extended Display Identification Data (EDID) using Display Data Channel (DDC) protocols.

### How to Set up Your PC for Use with Monitor (Windows)

The display settings for a typical Windows-based computer are shown below. However, the actual screens on your computer will differ depending on the version of Windows and video card equipped with the computer. Even though the actual screen may look different from example displayed below, basic set-up routine will apply in most cases.

- 1 Go to the Window's CONTROL PANEL by clicking START, SETTINGS, CONTROL PANEL.  
=> The CONTROL PANEL Window is displayed.
- 2 Select the DISPLAY icon from this window.  
=> The DISPLAY PROPERTIES dialog box is displayed.
- 3 Select the SETTINGS tab to display your computer's video output settings.
- 4 Set the "Screen Resolution" settings to 1024x768 PIXELS. For COLOR QUALITY, select 24 BIT COLOR (might also be expressed as 16 million colors).
- 5 If a vertical-frequency option is available, set the value to 60 or 60 Hz.
- 6 Click OK to complete the setting.

#### Note:

Both screen position and size will vary, depending on the type of PC graphics card and its resolution selected. See page 45 for an overview of the supported resolutions.

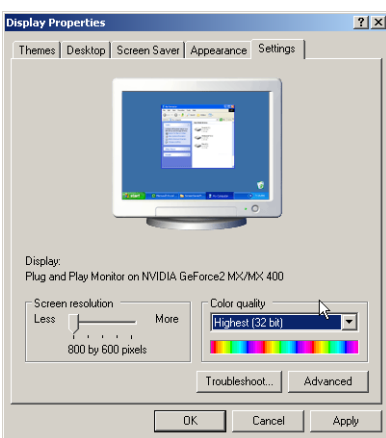
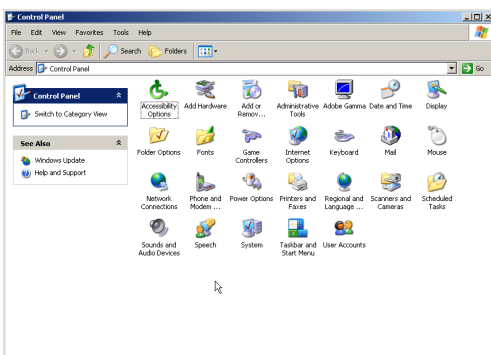



## 6. BASIC FUNCTIONS

### 6.1 POWERING ON / OFF

Make sure the monitor is plugged into the wall outlet and the main AC switch located in the rear of the monitor is switched to ON position. If the power is plugged in and the AC switch is on, the STATUS LED will illuminate in orange color.

#### Using Front Panel or Remote Control

- 1 Press the POWER key on the monitor panel or the remote control.  
=> The monitor will now turn on after a brief pause. The STATUS LED will now turn green to indicate power on status.
- 2 Turn off the power by pressing the POWER key on the front panel or the remote control again.

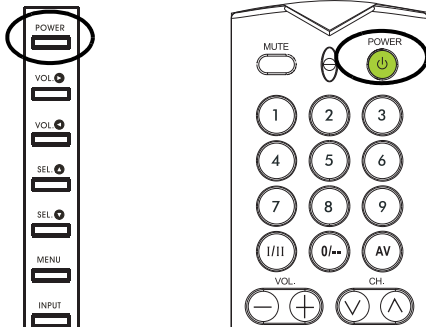

### 6.2 SELECTING SIGNAL SOURCE

#### Using Front Panel or Remote Control

- 1 Press the INPUT key on the monitor panel or the AV key on the remote control.
- 2 Pressing the INPUT or AV key will cycle the monitor through all available input signal sources in the following order:

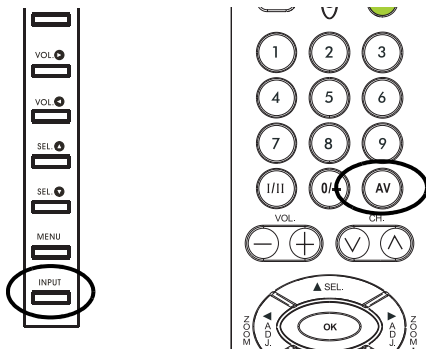
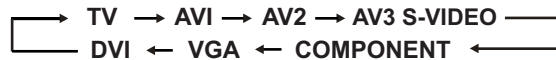

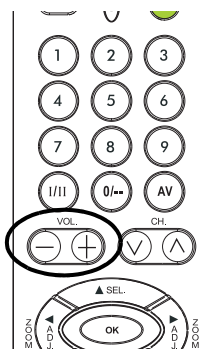
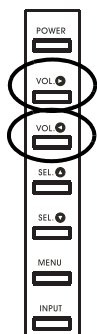

### 6.3 VOLUME ADJUSTMENT

#### Using Front Panel or Remote Control

- 1 Press VOLUME + on either the monitor panel or on the remote control to turn up sound volume.
- 2 Press VOLUME - on either the monitor panel or on the remote control to turn down sound volume.

**Note:**

If the monitor's built-in speakers are turned off, then the volume controls will not affect volume generated by the built-in speaker.

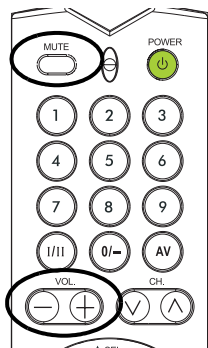

#### Using MUTE

- 1 Press the MUTE key to silence the volume. When the monitors volume is muted, the monitor will display MUTE on the upper right corner of the screen.
- 2 Press the the VOLUME keys, or press the MUTE key again to deactivate the mute function.

**Note:**

If the monitor's built-in speakers are turned off, then the volume controls will not affect volume generated by the built-in speaker.



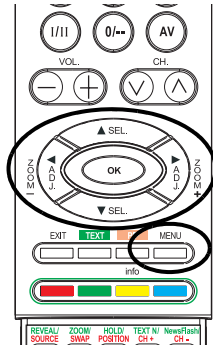

### 6.4 ON-SCREEN DISPLAY MENU

#### Accessing OSD Menu via Remote Control or Front Panel

The On-Screen Display (OSD) menu allows access to setup various parameters equipped with this display.

- 1 To access the OSD menu, press MENU button on the monitor panel or remote control.
- 2 Navigation through the OSD Menu can be accomplished using the arrow keys on the remote control or monitor panel SEL keys.

### 6.5 ON-SCREEN DISPLAY STATUS

The On-Screen Status Display shows detailed information regarding the operational status of the monitor. The status display automatically appears whenever there is a change in the state of the monitor such as channel change or input change. The status display will automatically disappear after a timeout period.

#### Showing Display Status

- 1 Press the Info key on the remote control to manually show the Status Display.

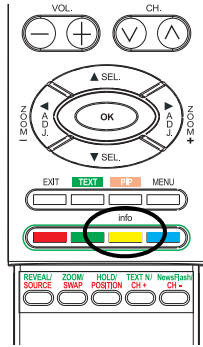

#### AV Mode



#### Component Mode



#### RGB/DVI Mode

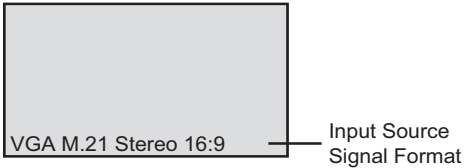

## 6.6 UNDERSTANDING WIDESCREEN MODES

This monitor is capable of displaying a widescreen image on the native 16:9 aspect ratio screen. However, not all available video content fits perfectly in a widescreen (16:9) format resulting in unused screen space. This monitor is capable of displaying images in various formats that are suitable for various types of content depending on its size.

### 6.6.1 4:3 (SQUARE) CONTENT

Content from traditional TV, VCR, and some DVD's are formatted using a "square" 4:3 format. When viewing content in this "Square" format the following viewing modes are suitable.



#### 4:3 (NORMAL)

In 4:3 mode, the original 4:3 image is preserved but black bars are used to fill the the extra space on the left and right.



#### 16:9 (FULL)

The original 4:3 image is proportionally stretched to fill the entire screen. This is the default setting from factory.

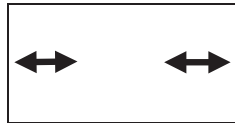

#### CINERAMA

The original 4:3 image is expanded in both the horizontal and vertical directions. The center of the picture is almost normal while the edges are considerably expanded.

### 6.6.2 WIDESCREEN CONTENT

Depending on the content displayed on this 16:9 monitor, you may notice smaller black bars on top or bottom of the screen. Use the following zoom modes to eliminate black bars.

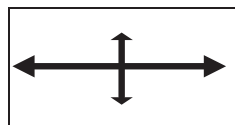

#### ZOOM:

Zoom is set to stretch 2.35:1 content to full screen eliminating black bars.



#### ZOOM↑:

Zoom ↑ shifts the image up to display sub-titles.

## 6.7 CHANGING ASPECT RATIOS

### Using Remote Control

- 1 All widescreen viewing modes are available by pressing the ZOOM + or ZOOM - key:

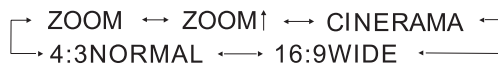

### Note:

- Under RGB(VGA) and DVI input modes, only 16:9 WIDE and 4:3 Normal modes are available.
- When displaying Y Pb Pr signals, the Cinerama mode is not available.

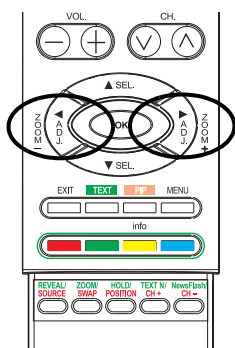



## 7. ADVANCED FUNCTIONS

PICTURE	SOUND	TV	OTHER
Contrast		52	
Brightness		50	
Colour		50	
Sharpness		50	
Tone		7600° K	
Auto format		ON	
Noise reduction		High	
* * Select      * * Adjust			

PICTURE	SOUND	TV	OTHER
Contrast		80	
Brightness		50	
Tone		7600° K	
V-Size		50	
V-Position		50	
H-Size		50	
H-Position		50	
Clock Phase		50	
* * Select      * * Adjust			

### 7.1 PICTURE CONTROLS

#### 7.1.1 ADJUSTING PICTURE SETTINGS

Various picture adjustments can be set using the Picture Adjustment OSD menu.

- 1 Press the MENU key on the monitor panel or remote control.
- 2 Use the ADJ ◀ or ADJ ▶ key to select the PICTURE option from the menu.  
=> Various picture settings are available from the PICTURE menu.
- 3 Use the SEL ▲ or SEL ▼ key to select the option that you wish to adjust.
- 4 Press the ADJ ◀ or ADJ ▶ key to change the setting.
- 5 Press the EXIT key to close the OSD screen, or press the SEL ▲ or SEL ▼ key to keep adjusting.

#### Notes:

- H-Position, H-Size, V-Position, V-Size adjustments are only available in RGB(VGA), DVI and Component input with Y PB/PR.
- When using Component input with Y CB/CR signals, H-Size, H-Position, V-Position and V-Size settings are not available.

### Explanation of Various Picture Control Settings

<p><b>CONTRAST</b> Adjust Contrast to increase or decrease the level of white in the video picture. Increasing contrast will make white areas of the video picture brighter. Contrast works in conjunction with Brightness.</p>
<p><b>BRIGHTNESS</b> Adjust brightness to enhance the level of dark areas in the video picture such as night scenes and shadow scenes. Increasing brightness will make dark areas more visible.</p>
<p><b>COLOR</b> Use color to adjust the color saturation of the video picture. Increasing color will make the color more intense. Reducing color setting will make the color less intense.</p>
<p><b>SHARPNESS</b> Use sharpness to adjust the amount of detail enhancement to the video picture. Increasing the setting will enhance the edges of objects in the video picture. Decreasing the setting will reduce enhancement.</p>
<p><b>tone</b> Select the color temperature for white balance. There are three settings to choose from : Cold, Neutral, Warm.</p>
<p><b>AUTO FORMAT</b> Use to turn on the auto format of screen or turn off. System will determine the format according to the signal when you turn on the auto format, otherwise, the screen will remain in 16:9.</p>
<p><b>V-SIZE</b> Use to change vertical size of the picture. Increase to enlarge the picture size in the vertical direction. Decrease to reduce the picture size in the vertical direction.</p>
<p><b>V-POSITION</b> Use to change vertical position of the picture. Increase to shift the picture up. Decrease to shift the picture down.</p>
<p><b>H-SIZE</b> Use to change horizontal size of the picture. Increase to enlarge the picture size in the horizontal direction. Decrease to reduce the picture size in the horizontal direction.</p>
<p><b>H-POSITION</b> Use to change horizontal position of the picture. Increase to shift the picture to the right. Decrease to shift the picture to the left.</p>
<p><b>CLOCK PHASE</b> Use clock phase to fine-tune the monitor to perfectly synchronize to the video signal source under RGB(VGA) mode.</p>

**Notes:**

- H-Position, H-Size and V-Position adjustments are only available in RGB(VGA), DVI, and Component input modes higher than 480i.
- When using Component inputs with Y CB/CR signals, H-Size, H-Position, V-Size, V-Position settings are not available.

### 7.1.2 PICTURE-IN-PICTURE (PIP) / SIDE-BY-SIDE PICTURE (POP)

PIP and POP modes allow you to view two video input sources simultaneously.

#### Turning On PIP or POP Mode

- 1 Press the PIP key once on the remote control to activate PIP mode.
- 2 Press the PIP again to switch to POP mode.
- 3 Press the PIP key sequentially will cycle between:

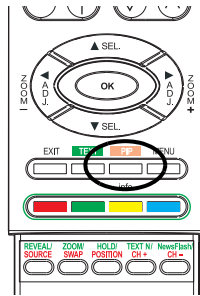
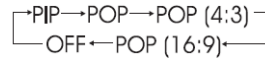

#### PIP Mode

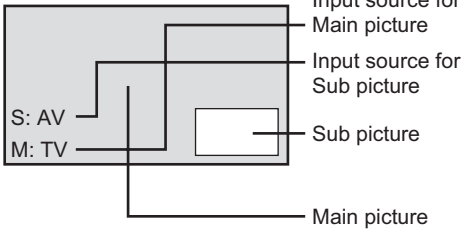

#### PIP mode:

In PIP mode, a small window is displayed in one of the four corners. The OSD on the upper right corner will denote the input selected for main picture (large screen) and the sub-picture (small screen) displayed.

#### Notes:

- Once PIP is turned off, the next time you return on PIP mode, the position of the subwindow will start at default position.
- In PIP mode it is not possible to combine video input (e.g. TV, AV, S-Video) with data input (e.g. DVI, RGB(VGA)).

#### POP Mode

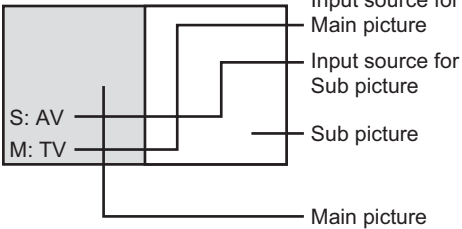

#### POP mode:

In POP mode, the screen will be split in half. The screen on the left side is the main picture and the screen on the right is the sub-picture. The OSD on the upper right corner will denote the input signal source for both the main and sub-pictures.

There are two Side-by-Side picture modes available in addition to the standard POP mode:

- POP (4:3) mode will display both main and subpicture in a 4:3 aspect ratio within the POP windows.
- POP (16:9) mode will display both main and sub-picture in 16:9 aspect ratio within the POP windows.

#### POP 4:3 Mode

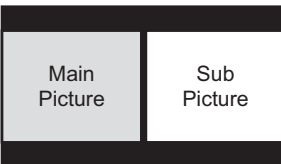

#### POP 16:9 Mode

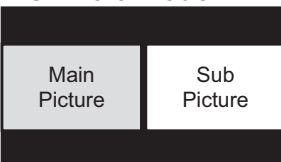

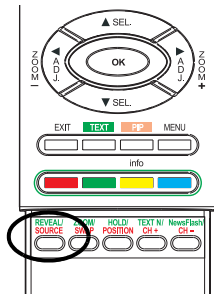

### Selecting Signal Source for Sub-Picture

Various signal sources can be displayed within the sub-window under PIP and Side-by-Side modes.

- 1 Once the PIP mode is turned on, you can change the sub-picture input source by pressing the SOURCE key.
- 2 Pressing the SOURCE key repeatedly will cycle through all available inputs for the sub-picture.

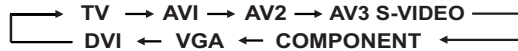

### Note:

In PIP mode it is not possible to combine video input (e.g. TV, AV, S-Video) with data input (e.g. DVI, RGB(VGA)).

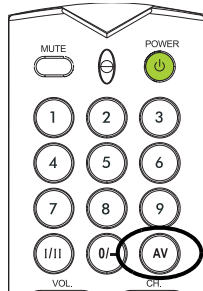

### Selecting Signal Source for Main Picture

- 1 Once the PIP mode is turned on, you can change the main picture input source by pressing the AV key.

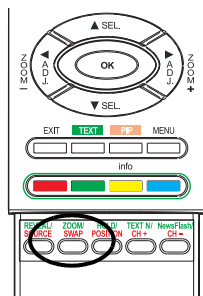

### Swapping Main and Sub-Window

You can swap the main picture and sub-picture.

- 1 Press the SWAP key once to swap.
- 2 Press the SWAP key once again to switch back.



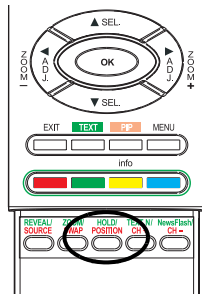

### Changing Location of PIP Image

There are four preset positions where the PIP sub-window can be positioned. Once the PIP mode is turned on, you can switch the PIP sub-picture position to any one of the four corners of the screen.

- 1 Press the POSITION key to switch positions.
- 2 Pressing the POSITION key repeatedly will cycle through all four corners of the screen.

### Sub-Picture Positions

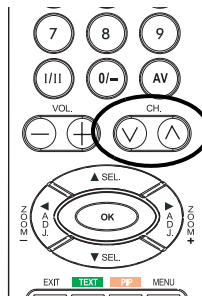
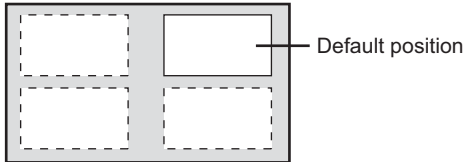

### Changing Channels in PIP or POP Mode

- 1 If TV mode is in main window, press the CHANNEL Up/Down key to change channels.

PICTURE	SOUND	TV	OTHER
Contrast		52	
Brightness		50	
Colour		50	
Sharpness		50	
Tone		7600° K	
Auto format		ON	
Noise reduction		High	
* * Select      * * Adjust			

PICTURE	SOUND	TV	OTHER
Contrast		52	
Brightness		50	
Colour		50	
Sharpness		50	
Tone		7600° K	
Auto format		ON	
Noise reduction		High	
* * Select      * * Adjust			

PICTURE	SOUND	TV	OTHER
Contrast		52	
Brightness		50	
Colour		50	
Sharpness		50	
Tone		7600° K	
Auto format		ON	
Noise reduction		High	
* * Select      * * Adjust			

PICTURE	SOUND	TV	OTHER
Contrast		80	
Brightness		50	
Tone		7600° K	
V-Size		50	
V-Position		50	
H-Size		50	
H-Position		50	
Clock Phase		50	
* * Select      * * Adjust			

### 7.1.3 SELECTING COLOR TEMPERATURE

This monitor is capable of applying various color temperatures (also known as White Balance) onto the video signal for display.

- 1 Press the MENU key on the monitor panel or remote control.
- 2 Use the ADJ ◀ or ADJ ▶ key to select the PICTURE option from the menu.
- 3 Use the SEL ▲ or SEL ▼ key to select the TONE option from the menu.
- 4 Press the ADJ ◀ or ADJ ▶ key to change the setting.
- 5 Press EXIT to close the OSD screen, or press the SEL ▲ or SEL ▼ key to keep adjusting.

### 7.1.4 FINE TUNING RGB(VGA) MODE

Due to various PC video cards and set-top boxes with differing specifications, it is likely that the initial video picture have subtle noise or imperfections. Please use the following procedures to adjust the picture quality when using under RGB(VGA) mode.

- 1 Press the MENU key on the monitor panel or remote control.
- 2 Use the ADJ ◀ or ADJ ▶ key to select the PICTURE option from the menu.
- 3 Use the SEL ▲ or SEL ▼ key to select the CLOCK PHASE option from the menu.
- 4 Press the ADJ ◀ or ADJ ▶ key to change the setting so that your video picture is the best quality.
- 5 Press EXIT to close the OSD screen, or press the the SEL ▲ or SEL ▼ key to keep adjusting.

PICTURE	SOUND	TV	OTHER
Contrast		52	
Brightness		50	
Colour		50	
Sharpness		50	
Tone		7600° K	
Auto format		ON	
Noise reduction		High	
* * Select		* * Adjust	

PICTURE	SOUND	TV	OTHER
Contrast		80	
Brightness		50	
Tone		7600° K	
V-Size		50	
V-Position		50	
H-Size		50	
H-Position		50	
Clock Phase		50	
* * Select		* * Adjust	

### 7.1.5 FIT PICTURE TO SIZE OF MONITOR

Due to various PC video cards and set-top boxes with differing specifications, it is likely that the initial picture may not fit exactly to the size of the monitor. Please use the following procedures to adjust the picture size and position.





- 1 Press the MENU key on the monitor panel or remote control.
- 2 Use the ADJ ◀ or ADJ ▶ key to select the PICTURE option from the menu.
- 3 Use the SEL ▲ or SEL ▼ key to select V-SIZE, V-POSITION, H-SIZE or H-POSITION from the menu.
- 4 Press the ADJ ◀ or ADJ ▶ key to change the setting so that your video picture is best fit within the display area of the monitor.
- 5 Repeat the procedure for the V-Size, V-Position, H-Size and H-Position settings until video picture is fully displayed within the monitor's display area.
- 6 Press EXIT to close the OSD screen.





## 7.2 SOUND CONTROLS

### 7.2.1 ADJUSTING SOUND SETTINGS

Various sound adjustments can be set using the Sound Adjustment OSD menu.

- 1 Press the MENU key on the monitor panel or remote control.
- 2 Use the ADJ ◀ or ADJ ▶ key to select the SOUND option from the menu.  
=> Various sound settings are available from the SOUND menu.
- 3 Use the SEL ▲ or SEL ▼ key to select the option that you wish to adjust.
- 4 Press the ADJ ◀ or ADJ ▶ key to change the setting.
- 5 Press the EXIT key to close the OSD screen, or press the SEL ▲ or SEL ▼ key to keep adjusting.

PICTURE	SOUND	TV	OTHER
Sound type		Stereo	
Bass		53	
Treble		50	
Balance		50	
Intern. Speaker		ON	
Audio Output		Variable	
  Select		  Adjust	

PICTURE	SOUND	TV	OTHER
Sound type		Stereo	
Bass		53	
Treble		50	
Balance		50	
Intern. Speaker		ON	
Audio Output		Variable	
  Select		  Adjust	

### Explanation of Various Sound Control Settings

<p><b>BASS</b> Adjusts the BASS level of the sound. For more bass response, increase the BASS level.</p>
<p><b>TREBLE</b> Adjusts the TREBLE level of the sound. For more vocal and high frequency response, increase the TREBLE level..</p>
<p><b>BALANCE</b> Adjusts the BALANCE level between LEFT and RIGHT channels.</p>
<p><b>SPEAKER</b> Sets the speakers to ON to turn on the speakers or sets the speakers to OFF to turn off. This setting will not affect AUDIO OUTPUT jacks.</p>
<p><b>AUDIO OUTPUT</b> Sets the type of audio output sent from the audio output jacks located in the rear of monitor. When set to VARIABLE, audio output is affected by the monitor's internal volume controls . When set to FIXED, the audio output bypasses the monitor's internal audio control so that functions such as bass, treble and volume controls have no effect.</p>

## 7.2.2 BUILT-IN AMPLIFICATION (SPEAKER)

### Turning On Built-in Amplification

This monitor is equipped with a built-in amplification for optional external speakers. You can switch the amplification ON or OFF using the OSD. Because these speakers are general purpose, you may consider switching them OFF during hi-fidelity playback of movies or other content.

- 1 Press the MENU key on the monitor panel or remote control.
- 2 Use the ADJ ◀ or ADJ ▶ key to select the SOUND option from the menu.
- 3 Use the SEL ▲ or SEL ▼ key to select the INTERN. SPEAKER option.
- 4 Press the ADJ ◀ or ADJ ▶ key to change the setting (ON/OFF).
- 5 Press the EXIT key to close the OSD screen, or press the SEL ▲ or SEL ▼ key to keep adjusting.

PICTURE	SOUND	TV	OTHER
Sound type		Stereo	
Bass		53	
Treble		50	
Balance		50	
Intern. Speaker		ON	
Audio Output		Variable	
◆ ◆ Select      ◆ ◆ Adjust			

PICTURE	SOUND	TV	OTHER
Sound type		Stereo	
Bass		53	
Treble		50	
Balance		50	
Intern. Speaker		ON	
Audio Output		Variable	
◆ ◆ Select      ◆ ◆ Adjust			

## 7.2.3 FIXED / VARIABLE AUDIO OUTPUT

### Setting Output Using OSD Menu

You can set the type of output this monitor outputs from its rear panel audio output jacks. By using OSD menu, you can easily choose between variable or fixed audio outputs.

- 1 Press the MENU key on the monitor panel or remote control.
- 2 Use the ADJ ◀ or ADJ ▶ key to select the SOUND option from the menu.
- 3 Use the SEL ▲ or SEL ▼ key to select the AUDIO OUTPUT option.
- 4 Press the ADJ ◀ or ADJ ▶ key to change the setting:
  - When set to VARIABLE, the audio output is affected by the monitor's internal audio controls.
  - When set to FIXED, the audio output bypasses the monitor's internal audio controls.
- 5 Press the EXIT key to close the OSD screen, or press the SEL ▲ or SEL ▼ key to keep adjusting.

PICTURE	SOUND	TV	OTHER
Sound type		Stereo	
Bass		53	
Treble		50	
Balance		50	
Intern. Speaker		ON	
Audio Output		Variable	
◆ ◆ Select      ◆ ◆ Adjust			

PICTURE	SOUND	TV	OTHER
Sound type		Stereo	
Bass		53	
Treble		50	
Balance		50	
Intern. Speaker		ON	
Audio Output		Variable	
◆ ◆ Select      ◆ ◆ Adjust			

PICTURE	SOUND	TV	OTHER
Power Save		ON	
Menu Language		English	
AVI Input		Video	
AV2 Input		Video	
Pixel Shift		1 minute	
Burn-In Recovery		Normal	
S/W Version		040309	031003
◆◆ Select		◆◆ Adjust	

PICTURE	SOUND	TV	OTHER
Power Save		ON	
Menu Language		English	
AVI Input		Video	
AV2 Input		Video	
Pixel Shift		1 minute	
Burn-In Recovery		Normal	
S/W Version		040309	031003
◆◆ Select		◆◆ Adjust	

PICTURE	SOUND	TV	OTHER
Power Save		ON	
Menu Language		English	
AVI Input		Video	
AV2 Input		Video	
Pixel Shift		1 minute	
Burn-In Recovery		Normal	
S/W Version		040309	031003
◆◆ Select		◆◆ Adjust	

PICTURE	SOUND	TV	OTHER
Power Save		ON	
Menu Language		English	
AVI Input		Video	
AV2 Input		Video	
Pixel Shift		1 minute	
Burn-In Recovery		Normal	
S/W Version		040309	031003
◆◆ Select		◆◆ Adjust	

### 7.3 OSD MENU LANGUAGE

This monitor has multiple OSD Menu languages built-in including English, French, Spanish, Italian and German.

#### Setting OSD Menu Language

- 1 Press the MENU key on the monitor panel or remote control.
- 2 Use the ADJ ◀ or ADJ ▶ key to select the OTHER option from the menu.
- 3 Use the SEL ▲ or SEL ▼ key to select the MENU LANGUAGE option.
- 4 Press the ADJ ◀ or ADJ ▶ key to select the required OSD language.
- 5 Press the EXIT key to close the OSD screen, or press the SEL ▲ or SEL ▼ key to keep adjusting.

### 7.4 POWER SAVE MODE

This monitor is equipped with a Power Save mode under RGB(VGA) or DVI input modes. When there are no signals detected by the monitor for 15 minutes, the monitor will automatically go into sleep mode until signal is restored.

#### Setting Power Save Mode

- 1 Press the MENU key on the monitor panel or remote control.
- 2 Use the ADJ ◀ or ADJ ▶ key to select the OTHER option from the menu.
- 3 Use the SEL ▲ or SEL ▼ key to select the POWER SAVE option.
- 4 Press the ADJ ◀ or ADJ ▶ key to change the setting (ON/OFF)
- 5 Press the EXIT key to close the OSD screen, or press the SEL ▲ or SEL ▼ key to keep adjusting.

## 7.5 INFORMATION DISPLAY

The information display sub-menu shows information about the monitor's firmware version number.

PICTURE	SOUND	TV	OTHER
Power Save		ON	
Menu Language		English	
AVI Input		Video	
AV2 Input		Video	
Pixel Shift		1 minute	
Burn-In Recovery		Normal	
S/W Version		040309	
		031003	
◆◆ Select		◆◆ Adjust	

### Viewing Firmware Version Number

- 1 Press the MENU key on the monitor panel or remote control.
- 2 Use the ADJ ◀ or ADJ ▶ key to select the OTHER option from the menu.
- 3 Press the EXIT key to close the OSD screen.

## 7.6 PIXEL SHIFT FUNCTION

Static images left on-screen for extended periods of time may leave a "ghost image" on plasma displays. For this reason the monitor is equipped with a protective function that detects static images. After a period of little or no image movement, the protection mechanism automatically shifts pixel positions to prevent creation of a "ghost image". The time interval between pixel shifting can be set by the user.

PICTURE	SOUND	TV	OTHER
Power Save		ON	
Menu Language		English	
AVI Input		Video	
AV2 Input		Video	
Pixel Shift		1 minute	
Burn-In Recovery		Normal	
S/W Version		040309	
		031003	
◆◆ Select		◆◆ Adjust	

### Setting Pixel Shift Interval

- 1 Press the MENU key on the monitor panel or remote control.
- 2 Use the ADJ ◀ or ADJ ▶ key to select the OTHER option from the menu.
- 3 Use the SEL ▲ or SEL ▼ key to select the PIXEL SHIFT option.
- 4 Press the ADJ ◀ or ADJ ▶ key to change the setting.
- 5 Press the EXIT key to close the OSD screen, or press the SEL ▲ or SEL ▼ key to keep adjusting.

PICTURE	SOUND	TV	OTHER
Power Save		ON	
Menu Language		English	
AV1 Input		Video	
AV2 Input		Video	
Pixel Shift		1 minute	
Burn-In Recovery		Normal	
S/W Version		040309	
		031003	
◆◆ Select		◆◆ Adjust	

### 7.7 BURN-IN RECOVERY

The Burn-In Recovery function is used to remove "ghost images" from the monitor display.

#### Using Burn-In Recovery

- 1 Press the MENU key on the monitor panel or remote control.
- 2 Use the ADJ ◀ or ADJ ▶ key to select the OTHER option from the menu.
- 3 Use the SEL ▲ or SEL ▼ key to select the BURN-IN RECOVERY option.
- 4 Press the ADJ ◀ or ADJ ▶ key to change the setting to ON.  
=> Once the Burn-in Recovery is set to ON, the monitor will display an all white pattern. This pattern will remove the residual "ghost image" from the screen.

#### Note:

The white pattern will be displayed on the monitor until cancelled by the user.

- 5 Press the EXIT key to cancel the display of the white pattern after the "ghost image" has been removed.
- 6 Press the EXIT key again to close the OSD screen, or press the SEL ▲ or SEL ▼ key to keep adjusting



## 7.8 TELETEXT

The Teletext service is available in many countries under a variety of names (TOP Text, Fasttext, FLOF test, Videotext). It is provided as a free service by some television broadcasters. This service provides a real wealth of information, available at any time, on weather, sporting results, news, games, etc. The information is presented in pages or organised in topics specified in colour on the screen and you can access this information by simply pressing the keys of the same colour on the remote control.

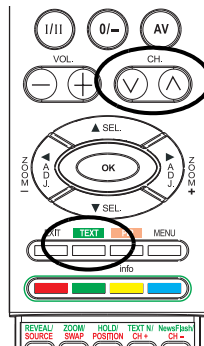

### Accessing Teletext

- 1 Press the TEXT key on the remote control.  
=> Teletext opens on the index page (100).
- 2 Press the CHANNEL ▲ or CHANNEL ▼ key to select the next and previous page, or enter its number using the numeric buttons.  
=> The page/subpage number appears:
  - In green when the page has not been found yet.
  - In white when the page has been found.

### Overview of Teletext Functions

#### ■ HOLD

Freezes the current page, preventing update and subpage display. To select this function, press the HOLD/POSITION key on the remote control. To cancel, press the HOLD/POSITION key again.

#### ■ REVEAL

Reveals hidden page information. Press the REVEAL/SOURCE key to show the information again.

#### ■ ZOOM

Press the ZOOM/SWAP key once to zoom in on the top part of the screen. Press twice to zoom in on the bottom part of the screen and three times to return to normal display.

If you want to show PIP in Teletext, press the PIP key on the remote control first to display PIP screen, then press the TEXT key on the remote control.

#### ■ Newsflash

When access NewsFlash page, Teletext is automatically enabled and displays the new information. To hide the information screen, press the NewsFlash/CH- key. Press the NewsFlash/CH- key again to show the information again.

#### ■ TEXT N

You can change the character of Teletext at any time. Press the TEXT/CH+ key to choose one of the seven Texts.

#### ■ Subtitles

Some channels provide subtitles for some of their programmes through Teletext. The numbers of the relevant pages are specified on the Teletext index page.

To display the subtitles, enter the number of the relevant page.

Once it is found, the subtitles appear in the TV picture. The header disappears after a couple of seconds. To display them again, press any button (except EXIT or the volume adjustment buttons) on the remote control.

To return to TV mode, press EXIT.

■ **Alarm page**

In some countries (Spain, Benelux, etc.), you can set a time to display certain Teletext pages (alarm pages).

To do this, display the relevant alarm page and press the ADJ ◀ or ADJ ▶ key to enter subpage mode. Enter the time instead of the subpage number (e.g. 1435 for 14:35) and press exit. The page will disappear and will appear again at the set time, as long as you do not change channels or switch off the set beforehand.

■ **Fasttext**

If fasttext is available, you can easily access the topic and relevant pages you want by pressing the **red**, **green**, **yellow** and **blue** buttons on the remote control.

In Teletext mode, volume controls remain available, but the relevant symbols are not shown on the screen.

## 7.9 TV FUNCTIONS (BDS4222R ONLY)

### 7.9.1 INITIAL SET UP

When you turn on the TV for the first time, the language selection menu appears.

- 1 Use the SEL ▲ or SEL ▼ key to select the required language (English, Francis, Deutsch, Italiano or Espanol).
- 2 Press the ADJ ◀ or ADJ ▶ key to confirm the selection.  
=> A list of countries appears.
- 3 Use the SEL ▲ or SEL ▼ key to select the country you are in. If your country is not on the list, select Other.  
=> The monitor will now search all available channels. It may take several minutes for the search to complete. When the search is complete, the screen will show how many channels are found then change to the EDITOR screen.

AUTO SEARCH	
Austraila	
Austria	
Belgium	
Eire	
France	
Germany	
Italy	
Spain	
Switzer land	
U.K.	
Other	
Return	
← ← Select	→ → Confirm

AUTO SEARCH	
Searching	On process
Standard	EURO
Frequency	62.45 MHZ
Channel Found	0

PICTURE	SOUND	TV	OTHER
Auto Search			
Manual Search			
Editor			
← → Select		← → Adjust	

PICTURE	SOUND	TV	OTHER
Auto Search			
Manual Search			
Editor			
← → Select		← → Adjust	

MANUAL SEARCH	
Standard	EURO
Frequency	62.25 MHZ
CH Name	-----
Fine-Tuning	62.25 MHZ
Save on CH:	-----
Text	1
Return	
← → Select	
← → Adjust	
OK TO Confirm	

MANUAL SEARCH	
Standard	EURO
Frequency	62.25 MHZ
CH Name	-----
Fine-Tuning	62.25 MHZ
Save on CH:	1
Text	1
Return	
← → Select	
← → Adjust	
OK TO Confirm	

### 7.9.2 MANUAL CHANNEL SEARCH

You may also make a manual search, in case, some channels are not stored during the initial set up.

- 1 Press the MENU key on the monitor panel or remote control.
- 2 Use the ADJ ◀ or ADJ ▶ key to select the TV option from the menu.
- 3 Use the SEL ▲ or SEL ▼ key to select the MANUAL SEARCH option.
- 4 Press the ADJ ◀ or ADJ ▶ key to confirm the selection.  
=> The MANUAL SEARCH menu is now displayed.
- 5 Select the Standard option.
- 6 Select the signal system then use the ADJ ◀ or ADJ ▶ key to search the frequency based on the current frequency shown on the menu. Or you can just key in the frequency with number key on the remote control.  
=> When a channel is found, the Save on CH option will be flashing with red color.
- 7 Press OK key to confirm the channel which is searched.

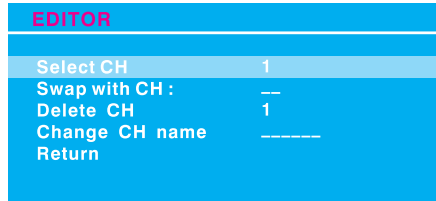
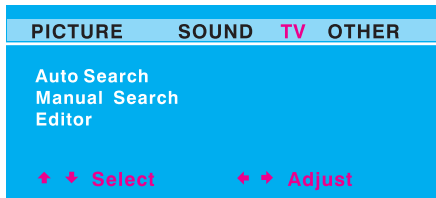

### 7.9.3 CHANNEL EDIT

You can swap, delete the channel, even change the name of channel in EDITOR menu.

- 1 Press the MENU key on the monitor panel or remote control.
- 2 Use the ADJ ◀ or ADJ ▶ key to select the TV option from the menu.
- 3 Use the SEL ▲ or SEL ▼ key to select the EDITOR option.
- 4 Press the ADJ ◀ or ADJ ▶ key to confirm the selection.  
=> The EDITOR menu is now displayed.
- 5 Use the SEL ▲ or SEL ▼ key to select SWAP, DELETE or CHANGE CH NAME to do the relevant setting.
- 6 After adjusting, press OK key to confirm.

### TV Mode (single Tuner)

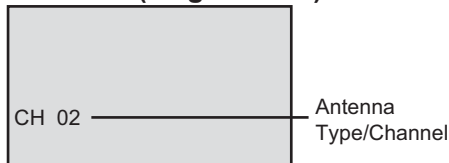

### 7.10 ON-SCREEN STATUS DISPLAY (TV MODE) (BDS4222R ONLY)

The On-Screen Status Display shows detailed information regarding the operational status of the monitor under TV mode. The status display automatically appears whenever there is a change in TV channels. The status display will automatically disappear after a timeout period.

#### Displaying Status

- 1 Press the Info key on the remote control.

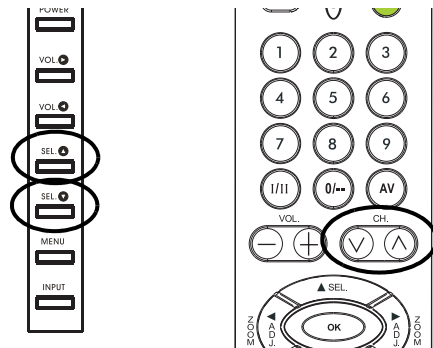

#### 7.10.1 CHANGING CHANNELS

To change TV channels, you can use either the remote control or the front panel keys.

- 1 Switch input to TV.
- 2 Press CHANNEL ▲ or CHANNEL ▼ key on the remote control to change channels. You can also press the SEL UP/DOWN keys on the monitor panel when there is no OSD on the screen.

### 7.10.2 SOUND TYPE

SOUND TYPE option sets audio reception settings for the TV tuner.

PICTURE	SOUND	TV	OTHER
Sound type		Stereo	
Bass		53	
Treble		50	
Balance		50	
Intern. Speaker		ON	
Audio Output		Variable	
◆ ◆ Select		◆ ◆ Adjust	

PICTURE	SOUND	TV	OTHER
Sound type		Stereo	
Bass		53	
Treble		50	
Balance		50	
Intern. Speaker		ON	
Audio Output		Variable	
◆ ◆ Select		◆ ◆ Adjust	

#### Accessing via OSD Menu

- 1 Press the MENU key on the monitor panel or remote control.
- 2 Use the ADJ ◀ or ADJ ▶ key to select the SOUND option from the menu.
- 3 Use the SEL ▲ or SEL ▼ key to select the SOUND TYPE option.
- 4 Use the ADJ ◀ or ADJ ▶ key to change the setting.  
See the table for reference about the available options:

Broadcast	Options
Mono	Mono, Automatic
Stereo	Mono, Stereo
Bilingual	Sound1, Sound2
NICAM bilingual	Sound1, Sound2, Sound3
AV	Stereo, Sound1, Sound2

- 5 After selecting the desired setting, press the EXIT key to close the OSD menu, or press the SEL ▲ or SEL ▼ key to keep adjusting.

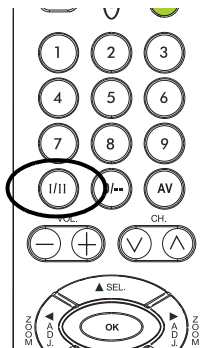

#### Accessing via Remote Control

- 1 Press the I/II key on the remote control repeatedly to cycle through all available audio modes.

## 8. TECHNICAL SPECIFICATIONS

### 8.1 SPECIFICATIONS

#### Display Panel

Screen Size	42"
Aspect Ratio	16:9
Number of Pixels	852 (Horizontal) x 480 (Vertical)
Pixel Pitch	1.08mm x 1.08mm
Luminance	1000 cd/m <sup>2</sup> , at 1/25 white window pattern

#### Power Source

Input Voltage	100 ~ 240 Vac; 50/60 Hz
Input Current	3.8 A
Inrush Current	60 A p-p/ 20 ms max.
Power Consumption	380±10% Watts (at 110 Vac/ color bar pattern)
Stand-by & Power Save	5Watts max. (at 110 Vac)

#### Connections

Connector Types	2 Scart Input Socket RCA Jacks for audio, video, Y/C <sub>B</sub> /C <sub>R</sub> and Y/P <sub>B</sub> /P <sub>R</sub> 4-pin DIN S-terminal for S-Video 9-pin Sub-D for RS-232 15-pin Sub-D for RGB 24-pin DVI
-----------------	---

#### Video/S-Video Signal

Type	Analog
Polarity	Positive
Amplitude	Video 1 Vp-p (with sync), S-Video Y=1 Vp-p C=0.286 Vp-p
Frequency	H: 15.734 kHz V: 60 Hz (NTSC) H: 15.625 kHz V: 50 Hz (PAL)
Input Impedance	75 ohms

#### Y/C<sub>B</sub>/C<sub>R</sub> or Y/P<sub>B</sub>/P<sub>R</sub> Signal (Component 1 & 2)

Type	Analog	
Polarity	Positive	
Amplitude	Y: 1 Vp-p (with sync) C <sub>B</sub> /P <sub>B</sub> : 0.7 ± 0.1 Vp-p C <sub>R</sub> /P <sub>R</sub> : 0.7 ± 0.1 Vp-p	
Frequency	H: 15.734 kHz V: 60 Hz (NTSC)	
Y/C <sub>B</sub> /C <sub>R</sub>	H: 15.625 kHz	V: 50 Hz (PAL)
Y/P <sub>B</sub> /P <sub>R</sub> : HDTV	H: 31 kHz	V: 60 Hz (480p)
	H: 45 kHz	V: 60 Hz (720p)
	H: 33 kHz	V: 60 Hz (1080i)
	H: 37.5 kHz	V: 50 Hz (720p)
	H: 31.25 kHz	V: 50 Hz (576p)
	H: 28.125 kHz	V: 50 Hz (1080i)

#### RGB Signal

Type	TTL
Polarity	Positive or Negative
Amplitude	RGB: 0.7 Vp-p
Frequency	H: support to 31k ~ 91 kHz V: support to 50 ~ 85 Hz

**DVI Signal**

Type Digital  
 Polarity Positive or Negative  
 Frequency H: support to 31k ~ 63 kHz  
 V: support to 50 ~ 85 Hz

**Audio Signal** Analog 500 mV<sub>rms</sub> / more than 22 kohms

**Pin Assignments for Sub-D Connector (In/ Loop Out)**

1 - RED	6 - RED GND	11 - GND
2 - GREEN	7 - GREEN GND	12 - SDA
3 - BLUE	8 - BLUE GND	13 - H-SYNC
4 - GND	9 - NC	14 - V-SYNC
5 - GND	10 - GND	15 - SCL

**Pin Assignments for 24-pin DVI Connector (Digital only)**

1 - TMDS Data 2-	9 - TMDS Data 1-	17 - TMDS Data 0-
2 - TMDS Data 2+	10 - TMDS Data 1+	18 - TMDS Data 0+
3 - TMDS Data 2/4 Shield	11 - TMDS Data 1/3 Shield	19 - TMDS Data 0/5 Shield
4 - TMDS Data 4-	12 - TMDS Data 3-	20 - TMDS Data 5-
5 - TMDS Data 4+	13 - TMDS Data 3+	21 - TMDS Data 5+
6 - DDC Clock	14 - +5 V Power	22 - TMDS Clock Shield
7 - DDC Data	15 - Ground (for +5 V)	23 - TMDS Clock+
8 - Not Connected	16 - Hot Plug Detect	24 - TMDS Clock-

**RGB/DVI for VESA Standard**

Mode No.	Mode	Resolution	Refresh Rate (Hz)	Horizontal Frequency (KHz)	Vertical Frequency (Hz)	Dot Rate (MHz)	V-sync Polarity (TTL)	V-sync Polarity (TTL)
1	VGA	640x480	60	31.469	59.940	25.175	-	-
2	VGA	640x480	72	37.861	72.809	31.500	-	-
3	VGA	640x480	75	37.500	75.000	31.500	-	-
4	VGA	640x480	85	43.269	85.008	36.000	-	-
5	SVGA	800x600	56	35.156	56.250	36.000	+	+
6	SVGA	800x600	60	37.879	60.317	40.000	+	+
7	SVGA	800x600	72	48.077	72.188	50.000	+	+
8	SVGA	800x600	75	46.875	75.000	49.500	+	+
9	SVGA	800x600	85	53.674	85.061	56.250	+	+
10	XGA	1024x768	60	48.364	60.004	65.000	-	-
11	XGA	1024x768	70	56.476	70.069	75.000	-	-
12	XGA	1024x768	75	60.023	75.029	78.750	+	+
13	XGA	1024x768	85	68.677	84.997	94.500	+	+
14	SXGA	1280x1024	60	63.981	60.020	108.000	+	+
18	DOS	720x400	70	31.469	70.087	28.322	+	-
19	VGA	640x480	50	31.469	50.030	25.175	-	-
20	HDTV	1280x720p	60	45.000	60.000	74.250	+	+
21	HDTV	1920x1080i )	60 (i)	33.750	60.000	74.250	+	+
22	VGA	640x350	70	31.469	70.087	25.175	-	+
23	WGA	852x480	60	31.413	59.835	30.000	-	-
24	APPLE	640x480	67	35.000	66.667	30.240	-	-
25	APPLE	832x624	75	49.725	74.550	57.283	-	-
26	APPLE	1152x870	75	68.681	75.062	100.000	-	-

\* These modes are not supported in DVI mode.



**Y/P<sub>B</sub>/P<sub>R</sub> for Component 1 and 2**

Mode	Resolution	Refresh Rate
1	640x480p	60
2	1920x1080i	60
3	1280x720p	60
4	720x576p	50
5	1920x1080i	50
6	1280x720p	50

**Max. Resolution** Up to 1280x1024

**Dimensions & Weight**

	With Stand Without Speakers	Without Stand Without Speakers
Width	1081 mm	1081 mm
Height	722 mm	677 mm
Depth	220 mm	95 mm
Weight	80.5 lbs/ 36.5 kg	77.6 lbs/ 35.2 kg

**Operating Conditions**

Temperature	0 ~ 40°C (32 ~104°F)
Relative Humidity	20 ~ 80%
Pressure	700 ~ 1114 hPa

**Operating Conditions**

Temperature	-5 ~ 50°C
Relative Humidity	20 ~ 80%
Pressure	600 ~ 1114 hPa
Vibration	X/Y/Z 0.5G/ 10 ~ 55 Hz (sweep)/ 10 minutes

**Acoustics**

(IHF A-weighted 1 meter) 40 dB max.

**Sound**

Residual hum (at max. Volume)	500 μW max.
Practical max. audio output (at 10% THD max.)	5 W +5 W max. /12 ohms
Sound distortion (at 250 mW 1 kHz)	1% max.
Audio output (input at 1.4 Vp-p)	>= 1.0 Vp-p

**Reliability Requirement**

The MTBF is 20,000 hrs under operation at 25 ± 5°C (Half luminosity, motion picture).

**Emission Requirement**

The unit meets the EMI limits in all screen modes, as qualified by FCC, class B, part 15.

**Power Management**

Mode	H-sync	V-sync	Video	Power dissipation
Normal	Pulse	Pulse	Active	Normal power
Stand-by	No pulse	No pulse	No video	Power off
Power saving	Pulse	No pulse	Blanked	Less than 5 Watts
Power saving	No pulse	Pulse	Blanked	Less than 5 Watts



## 9. CLEANING AND TROUBLESHOOTING

### 9.1 CLEANING

#### Cautions When Using the Plasma Display

- Do not bring your hands, face or objects close to the ventilation holes of the plasma display. Top of plasma display is usually very hot due to the high temperature of exhaust air being released through the ventilation holes. Burns or personal injuries may occur if any body parts are brought too close. Placing any object near the top of the display could also result in heat related damages to the object as well as the display itself.
- Be sure to disconnect all cables before moving the plasma display. Moving the display with its cables attached may damage the cables and thus cause fire or electric shock danger.
- Disconnect the power plug from the wall outlet as a safety precaution before carrying out any type of cleaning or maintenance procedure.

#### Front Panel Cleaning Instructions

- The front of the display has been specially treated. Wipe the surface gently using only a cleaning cloth or a soft, lint-free cloth.
- If the surface is particularly dirty, soak a soft, lint-free cloth in a mild detergent solution. Wring the cloth to remove excess liquid. Wipe the surface of the display to remove dirt. Then use a dry cloth of the same type to dry.
- Do not scratch or hit the surface of the panel with fingers or hard objects of any kind.
- Do not use volatile substances such as insect sprays, solvents and thinners.

#### Cabinet Cleaning Instructions

- If the cabinet becomes dirty, wipe the cabinet with a soft, dry cloth.
- If the cabinet is extremely dirty, soak a lint-free cloth in a mild detergent solution. Wring the cloth to remove as much moisture as possible. Wipe the cabinet. Use another dry cloth to wipe over until the surface is dry.
- Do not allow any water or detergent to come into contact with the surface of the display. If water or moisture gets inside the unit, operating problems, electrical and shock hazards may result.
- Do not scratch or hit the cabinet with fingers or hard objects of any kind.
- Do not use volatile substances such as insect sprays, solvents and thinners on the cabinet.
- Do not place anything made from rubber or PVC near the cabinet for any extended periods of time.

9.2 TROUBLESHOOTING

Symptom	Possible Cause	Remedy
No picture is displayed	<ol style="list-style-type: none"> <li>1 The power cord is disconnected.</li> <li>2 The main power switch on the back of the monitor is not switched on.</li> <li>3 The selected input has no connection.</li> <li>4 The monitor is in standby mode in RGB mode.</li> </ol>	<ol style="list-style-type: none"> <li>1 Plug in the power cord.</li> <li>2 Make sure the power switch is switched on.</li> <li>3 Connect a signal connection to the monitor.</li> <li>4 Press any key on your keyboard.</li> </ol>
Interference displayed on the monitor or audible noise is heard	Caused by surrounding electrical appliances, cars/motorcycles or fluorescent lights.	Move the monitor to another location to see if the interference is reduced.
Color is abnormal	The signal cable is not connected properly.	Make sure that the signal cable is attached firmly to the back of the monitor.
Picture is distorted with abnormal patterns	<ol style="list-style-type: none"> <li>1 The signal cable is not connected properly.</li> <li>2 The input signal is beyond the capabilities of the monitor.</li> </ol>	<ol style="list-style-type: none"> <li>1 Make sure that the signal cable is attached firmly.</li> <li>2 Check the video signal source to see if it is beyond the range of the monitor. Please verify its specifications with this monitor's specification section</li> </ol>
Display image doesn't fill up the full size of the screen	<ol style="list-style-type: none"> <li>1 If under RGB mode, the H-Size and V-Size is incorrectly set.</li> <li>2 If under AV1, AV2, or Component with 480i input, the 4:3 WIDE mode is switched on.</li> </ol>	<ol style="list-style-type: none"> <li>1 Use H-Size and V-Size to adjust the size of the video.</li> <li>2 Use the WIDE key to scroll through various full screen modes.</li> </ol>
Can hear sound, but no picture	Improperly connected source signal cable. 1.	Make sure that both video inputs and sound inputs are correctly connected.
Can see picture but no sound is heard	<ol style="list-style-type: none"> <li>1 Improperly connected source signal cable.</li> <li>2 Volume is turned all the way down.</li> <li>3 MUTE is turned on.</li> </ol>	<ol style="list-style-type: none"> <li>1 Make sure that both video inputs and sound inputs are correctly connected.</li> <li>2 Use VOLUME +/- to hear sound.</li> <li>3 Switch MUTE off by using the MUTE button.</li> </ol>
Some picture elements do not light up	Some pixels of the plasma display may not turn on	<p>This monitor is manufactured using an extremely high level of precision technology; however, sometimes some pixels of the monitor may not display.</p> <p>This is not a malfunction. Please see the enclosed warranty card for more information.</p>
After-Images can still be seen on the monitor after the monitor is powered off. (Examples of still pictures include logos, video games, computer images, and images displayed in 4:3 normal mode)	A still picture is displayed for an over extended period of time.	Do not allow a still image to be displayed for an extended period of time as this can cause a permanent after-image to remain on the monitor.

..

## 10. LIMITED WARRANTY (EUR)

### Two Year Free Labor

### Two Year Free Parts

#### WHO IS COVERED?

You must have proof of the date purchased to receive warranty service. A sales receipt or other document showing the date that you purchased the product is considered proof of purchase.

#### WHAT IS COVERED?

Warranty coverage begins the day you buy your product. For two years thereafter, all defective parts will be repaired or replaced and labor is free. After two years from the day of purchase, you pay for the replacement or repair of all parts, and for all labor charges. All parts, including repaired and replaced parts, are covered only for the original warranty period. When the warranty on the product expires, the warranty on all replaced and repaired parts also expires.

#### WHAT IS EXCLUDED?

Your warranty does not cover:

- labor charges for removal, installation or setup of the product, adjustment of customer controls on the product, and installation or repair of antenna systems outside of the product.
- product repair and/or part replacement because of misuse, accident, unauthorized repair or other cause not within the control of Philips Consumer Electronics Europe.
- reception problems caused by signal conditions or cable or antenna systems outside the unit.
- a product that requires modification or adaptation to enable it to operate in any country other than the country for which it was designed, manufactured, approved and/or authorized, or repair of products damaged by these modifications.
- incidental or consequential damages resulting from the product. (Some states do not allow the exclusion of incidental or consequential damages, so the above exclusion may not apply to you. This includes, but is not limited to, prerecorded material, whether copyrighted or not copyrighted.)
- modifications or adaptations to enable the product to operate in any country other than the country for which it was designed, manufactured, approved and/or authorized, or the repair of products damaged by these modifications.
- normal wear and tear (decreased light output of PDP module) over the product's lifetime.
- phosphor burn. Do not display static images for prolonged periods, otherwise phosphor burn might appear on part of the panel.
- limited quantity of cells (fine pixel elements) that do not produce light, or that remain lit after they should have turned off.

**WHERE IS SERVICE AVAILABLE?**

Warranty service is available in all countries where the product is officially distributed by Philips Consumers Electronics Europe. In countries where Philips Consumers Electronics Europe does not distribute the product, the local Philips service organization will attempt to provide service (although there may be a delay if the appropriate spare parts and technical manual(s) are not readily available).

**MAKE SURE YOU KEEP ...**

Please keep your sales receipt or other document showing proof of purchase. Attach it to this owner's manual and keep both nearby. Also keep the original box and packing material in case you need to return your product.

**BEFORE REQUESTING SERVICE ...**

Please check your owner's manual before requesting service. Adjustments of the controls discussed there may save you a service call.

**TO GET WARRANTY SERVICE,  
OR IF YOU HAVE QUESTIONS ...**

Please contact Philips at one of the telephone numbers below:

Austria .....	01 5465 75603
Belgium .....	02 275 0701
Cyprus .....	800 92256
Denmark .....	35 25 87 61
Finland .....	09 2290 1908
France .....	03 8717 0033
Germany .....	0696 698 4712
Greece .....	00800 3122 1223
Ireland .....	1 601 1161
Italy .....	02 4827 1153
Luxembourg .....	26 84 3000
Netherlands .....	053 482 9800
Norway .....	22 70 82 50
Poland .....	00800 311 1338
Portugal .....	800 831 363
Spain .....	917 456 246
Sweden .....	08 632 0016
Switzerland .....	02 2310 2116
United Kingdom .....	0207 949 0069

Repair must be performed by an authorized service center or a factory service center. If you do not live near a factory service center, contact your dealer. If your dealer is an authorized service center, he will arrange repair.

**REMEMBER ...**

Please record the model and serial numbers found on the product below. Also, please fill out and mail your warranty registration card promptly.

It will be easier for us to notify you if necessary.

MODEL # \_\_\_\_\_

SERIAL # \_\_\_\_\_wo\_\_\_\_\_





## 11. LIMITED WARRANTY (USA)

### Two Year Free Labor

### Two Year Free Parts

#### WHO IS COVERED?

You must have proof of the date purchased to receive warranty service. A sales receipt or other document showing the date that you purchased the product is considered proof of purchase.

#### WHAT IS COVERED?

Warranty coverage begins the day you buy your product. For two years thereafter, all defective parts will be repaired or replaced and labor is free. After two years from the day of purchase, you pay for the replacement or repair of all parts, and for all labor charges. All parts, including repaired and replaced parts, are covered only for the original warranty period. When the warranty on the product expires, the warranty on all replaced and repaired parts also expires.

#### WHAT IS EXCLUDED?

Your warranty does not cover:

- labor charges for removal, installation or setup of the product, adjustment of customer controls on the product, and installation or repair of antenna systems outside of the product.
- product repair and/or part replacement because of misuse, accident, unauthorized repair or other cause not within the control of Philips Consumer Electronics North America.
- reception problems caused by signal conditions or cable or antenna systems outside the unit.
- a product that requires modification or adaptation to enable it to operate in any country other than the country for which it was designed, manufactured, approved and/or authorized, or repair of products damaged by these modifications.
- incidental or consequential damages resulting from the product. (Some states do not allow the exclusion of incidental or consequential damages, so the above exclusion may not apply to you. This includes, but is not limited to, prerecorded material, whether copyrighted or not copyrighted.)
- modifications or adaptations to enable the product to operate in any country other than the country for which it was designed, manufactured, approved and/or authorized, or the repair of products damaged by these modifications.
- normal wear and tear (decreased light output of PDP module) over the product's lifetime.
- phosphor burn. Do not display static images for prolonged periods, otherwise phosphor burn might appear on part of the panel.
- limited quantity of cells (fine pixel elements) that do not produce light, or that remain lit after they should have turned off.

**WHERE IS SERVICE AVAILABLE?**

Warranty service is available in all countries where the product is officially distributed by Philips Consumers Electronics North America. In countries where Philips Consumers Electronics North America does not distribute the product, the local Philips service organization will attempt to provide service (although there may be a delay if the appropriate spare parts and technical manual(s) are not readily available).

**MAKE SURE YOU KEEP ...**

Please keep your sales receipt or other document showing proof of purchase. Attach it to this owner's manual and keep both nearby. Also keep the original box and packing material in case you need to return your product.

**BEFORE REQUESTING SERVICE ...**

Please check your owner's manual before requesting service. Adjustments of the controls discussed there may save you a service call.

**TO GET WARRANTY SERVICE U.S.A.,  
PUERTO RICO OR US VIRGIN ISLANDS ...**

Please contact Philips at:

1-877-835-1838

or an authorized service center to arrange repair. (In U.S.A., Puerto Rico and U.S. Virgin Islands, all implied warranties, including implied warranties of merchantability and fitness for a particular purpose, are limited in duration to the duration of this express warranty. But, because some states do not allow limitations on how long an implied warranty may last, this limitation may not apply to you.)

**TO GET WARRANTY SERVICE IN CANADA ...**

Please contact Philips at:

800-661-6162 (French Speaking) (within Canada only)

800-531-0039 (English Speaking)

(In Canada, this warranty is given in lieu of all other warranties. No other warranties are expressed or implied, including any implied warranties of merchantability or fitness for a particular purpose. Philips is not liable under any circumstances for any direct, indirect, special, incidental or consequential damages, howsoever incurred, even if notified of the possibility of such damages.)

**REMEMBER ...**

Please record the model and serial numbers found on the product below. Also, please fill out and

mail your warranty registration card promptly. It will be easier for us to notify you if necessary.

MODEL # \_\_\_\_\_

SERIAL # \_\_\_\_\_wo\_\_\_\_\_